

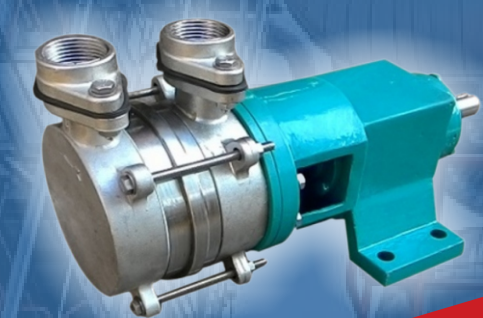

B. J. Pumps & Equipment's

All types of Pumps, Seals & Services

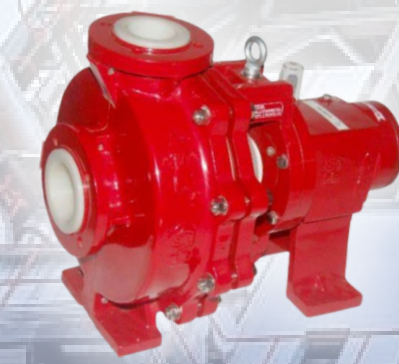
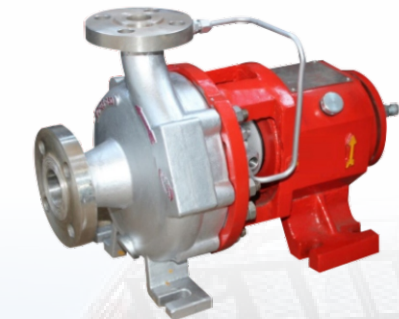

APPLICATION

PRO. Series pumps are an ideal choice for pumping acids and alkalis, typical applications include Chemical & Pharmaceutical industries chlor alkali plants, steel plants, water treatment plant

MODEL	SUCTION (MM)	DELIVERY (MM)	IMPELLER (MM)	HP	RPM
PRO. 100	25	25	100	01	2900
PRO. 120	40	32	120	02	2900
PRO. 130	40	40	135	03	2900
PRO. 160R	40	40	142	3	2900
PRO. 160	75	40	157	5	2900
PRO. 170	75	50	160	7.5	2900
PRO. 40	50	40	190	12.5	2900
PRO. 50R	40	40	190	02	1440
PRO. 50	75	40	205	03	1440
PRO. 55	75	50	212	05	1440

Head in mtr.		Capacity in M3/Hr				
04	06	07	09	10	11.5	
13	11	08	05	02	0	
05	07	11	13	15	17	
22	19	13	10	05	0	
08	10	15	18	20	23	
25	20	15	10	05	0	
10	15	20	21	23	24	
25	20	10	05	02	0	
10	15	20	25	27	29	
35	30	20	10	05	0	
10	15	20	25	30	33	
55	45	40	30	20	0	
25	30	35	40	45	50	
40	35	30	25	10	0	
08	8.5	09	10	10.5	11	
24	20	15	10	0.5	0	
10	11	12	13	14	0	
32	25	15	05	0	0	
06	10	12	14	15	15.5	
50	45	35	16	0.5	0	

B. J. Pumps & Equipment's

- HAED OFFICE :**
 Plot No.52, Yogy State-2, Near Karmatur Chowkdi, G.I.D.C. Ankleswar.
- VAPI OFFICE :**
 CM-18/P/2, Shop No.4, Opp. VIA Char Rasta, G.I.D.C. Vapi - 396195.
 ☎ : 9328922207 / 9328418896
 ✉ : bjpumps.vapi@gmail.com / mukesh.bjpump@gmail.com
 🌐 : www.bjpumpsandequipments.com
- SARIGAM OFFICE :**
 Plot No. 1501, Shop No.01, Fansha Chokwdi,
 Near Water Tank, G.I.D.C. Sarigam.



Pumps & Equipments

Available in : Pumps spares make for

ALFA, ARO IR., AIR TECH, ANTICO, KILOSKAR, KSB FOROULIED, RAJEDIA, SWARAJ, INVESTA, NAKLANK, SHIVPUMP, ROTO FLUD, PRICE, MEGATECH, WELL TEC

ABOUT US

Established in the year 2002, at Ankleshwar, We B. J. Pumps & Equipment, have inched forward as well recognized manufactures of Chemical Process Pumps & Equipments.

These pumps are used for applications such as transfer of various corrosive & toxic liquids/chemicals. The entire product assortment is designed and developed in accordance to high reliability, Safety and optimization standards well specified in the global arena.

Authorised Dealers in : Air tech Aodd pump, Shiv pump SS, Alfa pump, (PP, PVDF) Maxflow Barrel mechanical seal, Shaft, sleeve.

Available in Pump Spares, KSB, Kirloskar, Investa, Antico, Alfa, Floroulined, Rajedia, Orbit Pump, Swaraj Pumps & All types of Mechanical Seals & Sleeves.

QUALITY POLICY

We are aware of the fact that quality of our product that we offer are of paramount importance for us to be ahead in this highly competitive business.

Hense 'quality' is given a significant importance in our business. We carry out stringent quality checks on the pumps and motors before they are ready for dispatch. We have our quality control team who ensure supply of zero defect products from our side. we check for quality of our pumps on various parameters like:

- ▶ Efficiency
- ▶ Noise and sound of the machines
- ▶ Safety
- ▶ Power consumption
- ▶ Quality of the components used

CROSS SECTION

SR. NO.	NAME OF PART	MATERIAL OF CONST.
1.	Impeller	PVDF
2.	Volute Casing Liner	PVDF
3.	Shaft Sleeve	Ceramic/SIC
4.	Casing Armour	C.I.
5.	Mechanical Seal Stationary	Ceramic/SIC/GPT/SIC
6.	Black Plate	PVDF
7.	Shaft	EN19/EN41/SS316
8.	Bearing Housing	C.I.

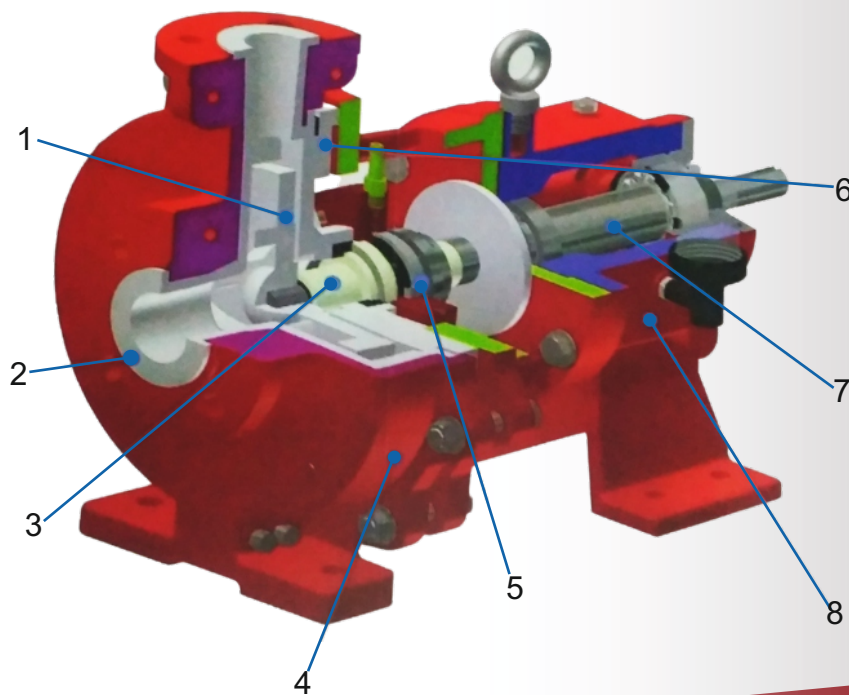

OUR PRODUCTS

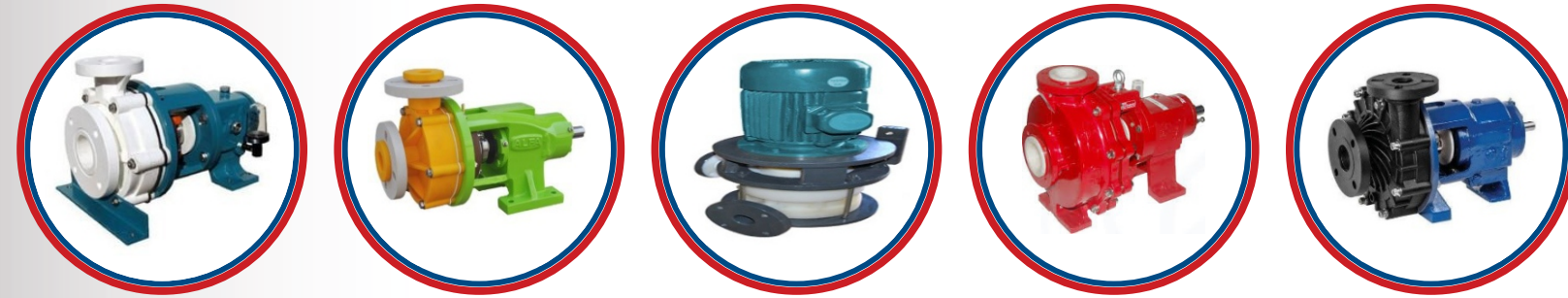

PP/PVDF CENTRIFUGAL PUMP



AIR OPERATED DOUBLE DIAPHRAGM PUMP

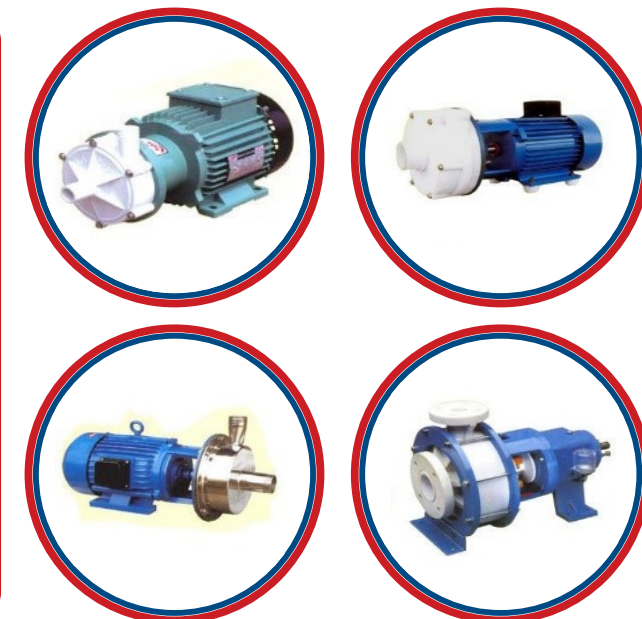

PP/ SS MONO BLOCK PUMP



SS/CI CENTRIFUGAL PUMP
SLEF PRIMING PUMP
SS MONO BLOCK PUMP



OUR PRODUCTS

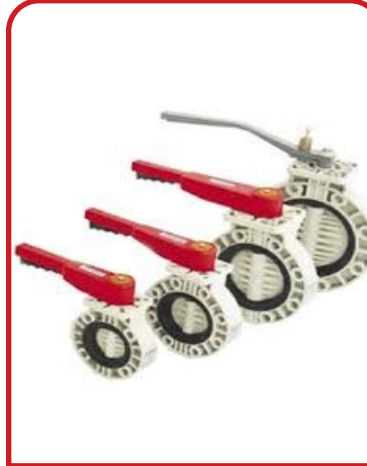

SPAKLER FILETTER /PP VRTICAL PUMP/BAREL PUMP /PPSTANNER /PRIMING CHEMBER

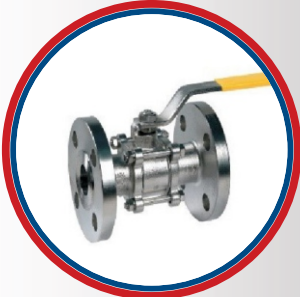

PP/PVDF/PFA LAINE/SS/MS/BALL VALVE /NRV/STANNER /SIDE GLASS

OUR PRODUCTS



PP/PVDF/PFA LAINE/SS/MS/BALL VALVE /NRV/STANNER /SIDE GLASS

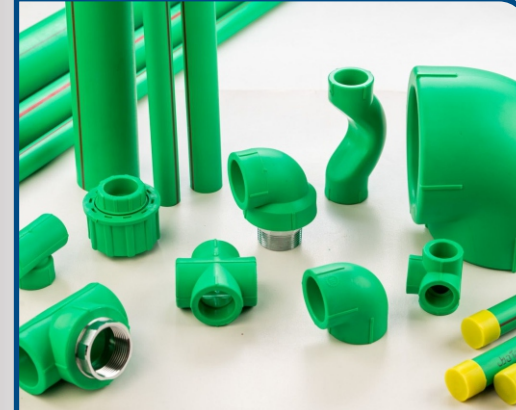

PPRC & PPR PIPE & FITTING, BALL VALVE, SIDE GLASS, FOOT VALVE



ALL TYPE OF MECHANICAL SEAL